

211. SIVULIIKKEET

Liite 3

1. Pohkeenväistö  
uralla

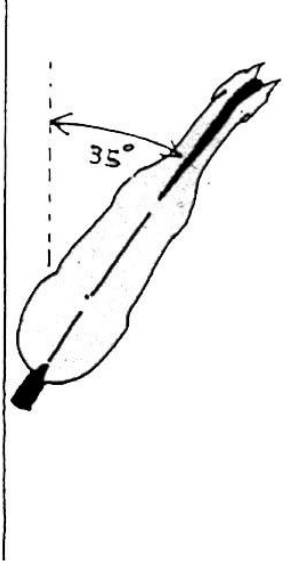

2. Pohkeenväistö  
lävistäjällä

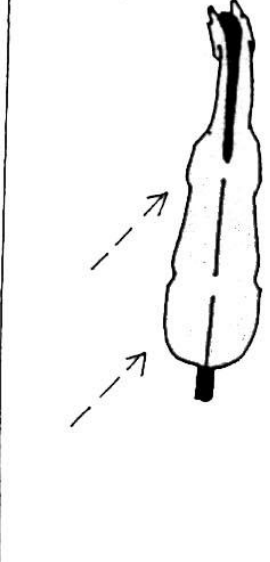

3. Avotaiivutus  
(Shoulder in)

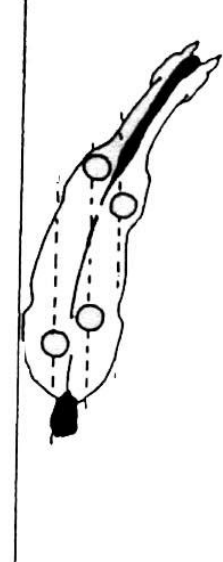

4. Sulkutaiivutus  
(Half-pass)

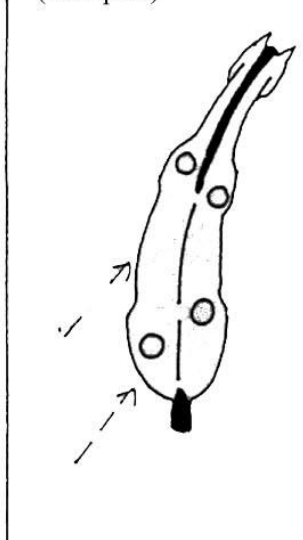

5. Sulkutaiivutus  
(Travers)

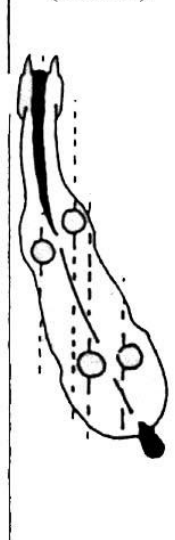

6. Vastataivutus  
(Renvers)

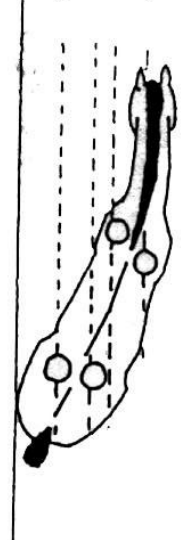



# Sallitut kuolaimet

## Sallitut kankisuitsituksen kuolaimet

### Bridong-kuolaimet :

1. Loose ring bridoon bit (Perusbridong-kuolain)
- 2.a,b,c, Bridoon bit with jointed mouthpiece where the middle piece should be rounded. Eggbutt sides also allowed. (Kaksinivelinen bridong, oliivirenkaalliset myös sallittu.)
- 2 d Bridoon bit with rotating middle piece (Kolmipalainen, jossa kiertyvä rulla keskellä (WH Ultra).
- 2 e Bridoon Rotary bit with rotating middle piece. (Nivel- tai kolmipalainen kuolain, jossa kiertyvä rulla keskellä)
3. Egg-butt bridoon bit (Oliivirengas -bridong)
4. Bridoon bit with hanging cheeks (Bridong, varsikiinnitys poskiremmiin)

### Kankikuolaimet:

5. Half-moon curb bits (Kaareva suuosa)
- 6.+7. Curb bit with straight cheeks and port (Suora varsi ja kielentila)
8. Curb bit with port and sliding mouthpiece (Weymouth) A curb bit with rotating lever arm is also allowed. (Kielentila ja liikkuva suuosa (Weymouth)).
9. Variation of bits No 6, 7 & 8 (Nron 6, 7 ja 8 muunnelma)
10. Curb bit with S-curved cheeks (Kankikuolain S-muotoisella, kaarevalla varrella)
11. Curb chain (metal or leather or a combination)  
(Kankiketju, metallia tai nahkaa tai yhdistelmä)
12. Lip strap (Ketjuhina)
- 13+14. Leather/rubber cover for curb chain (Ketjun nahka-/kumisuoja)

## Sallitut nivelsuitsituksen kuolaimet

1. Loose ring snaffle (Perusnivelkuolain)
- 2.a,b,c, d, e  
Snaffle with jointed mouthpiece where middle piece should be rounded (Kaksinivelinen kuolain)
3. Egg-butt snaffle (Oliivirengasnivelkuolain)
4. Racing snaffle D-ring (D-rengasnivelkuolain)
5. Egg-butt snaffle with cheeks (Varrellinen oliivirengasnivelkuolain)
6. Loose ring snaffle with cheeks (Fulmer) (Varrellinen kuolain liikkuvalla (pyörivällä) renkaalla)
7. Snaffle with upper cheeks only (Nivelkuolain, jossa vain ylävarret)
8. Hanging cheek snaffle (Nivelkuolain, varsikiinnitys poskiremmiin)
9. Straight bar snaffle. Permitted also with mullen mouth and with eggbutt rings  
(Suora kuolain. Myös kielentila sekä oliivirenkaat sallittu)
10. Snaffle with rotating mouthpiece (Nivel kiertyvällä suuosalla)
11. Snaffle with rotating middle piece (Kolmipalainen, jossa kiertyvä rulla keskellä (WH Ultra))
12. Rotary bit with rotating middle piece.  
(Nivel- tai kolmipalainen kuolain, jossa kiertyvä rulla keskellä).

**Sallitut kankisuitsituksen kuolaimet:**

Bridongit:

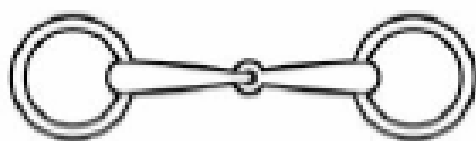

1

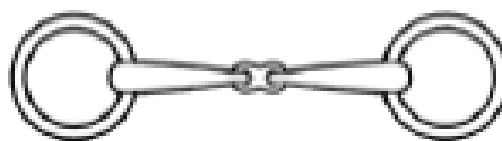

2a

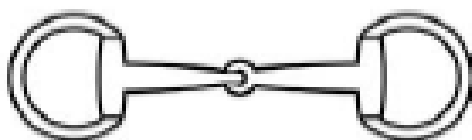

3

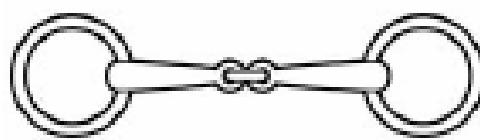

2b

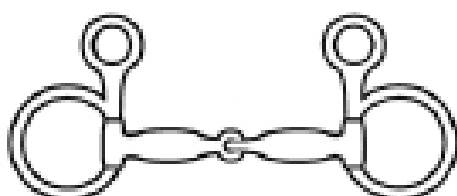

4

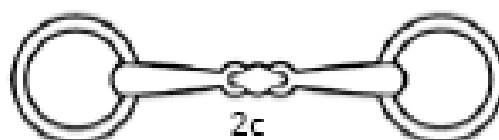

2c



2d



2e



Kankikuolaimet:

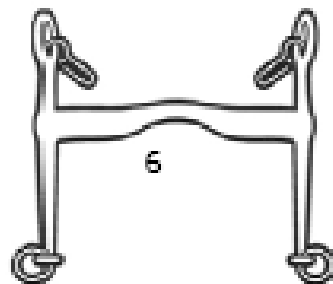
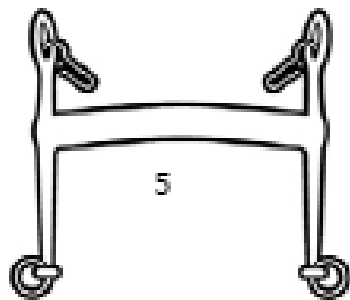

Note: Curb chain hooks must not be fixed.

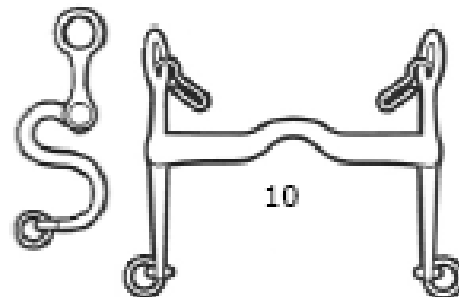
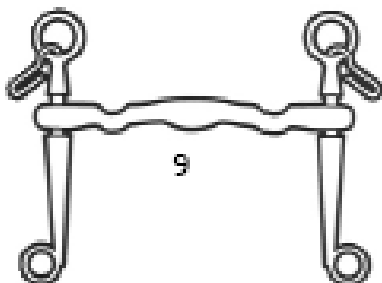
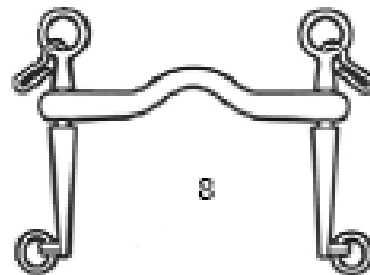
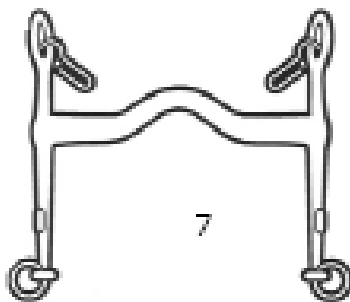

Sallitut nivelsuitsituksen kuolaimet:



1



2a

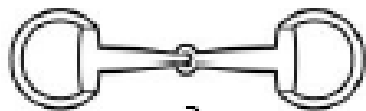

3

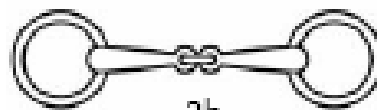

2b

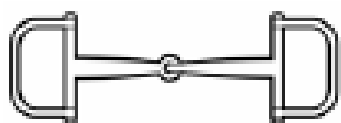

4

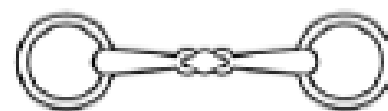

2c

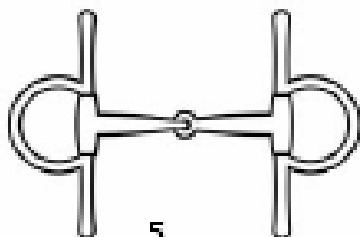

5

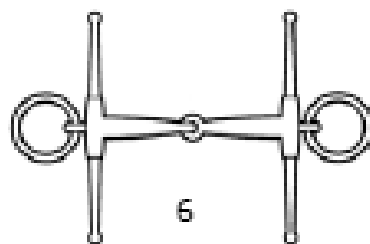

6



7

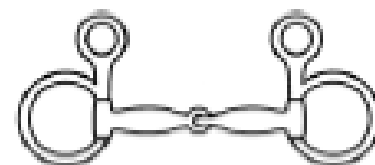

8

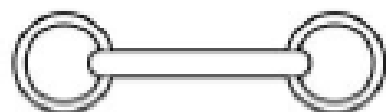

9

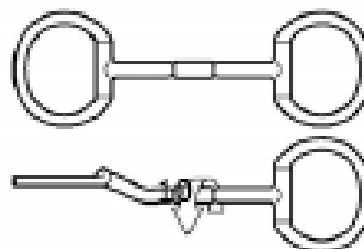

11

...jatkuu:

## 12. Kiertyvät kuolaimet

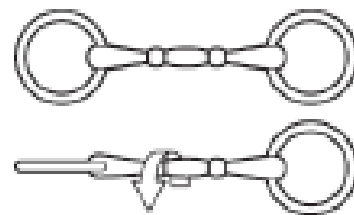
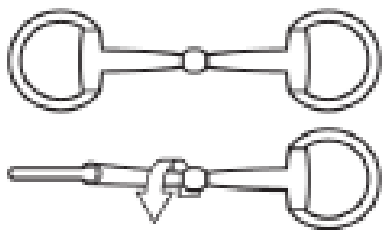
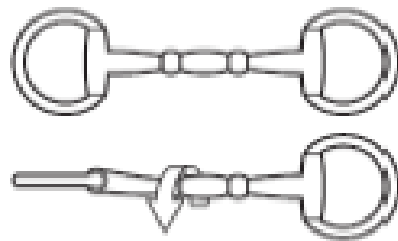
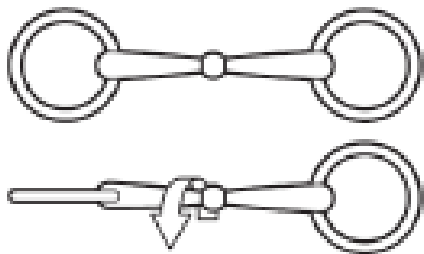

## Satulointi ja suitsitus

### Sallitut suitsitukset:

#### **Permitted nosebands**

1. Dropped noseband



2. Cavesson noseband



3. Flash noseband



4. Crossed noseband / Mexican noseband



5. Combined noseband - no throat lash



6. Micklem bridle

1, 3, 4 and 6 are not permitted when a double bridle is used.

5, when used as a double bridle, the lower strap of the nose band is not allowed.

Example of Double bridle with cavesson noseband bridoon bit and curb chain



Example of permitted Dressage saddle



Double sliding side reins (triangle/dreieck zügel)

